



Chain Clamp Manual

Model 260

About Us

We appreciate your business!

Congratulations on your new SAWYER product. We are proud to have you as our customer and will strive to provide you with the best service and reliability in the industry. This product is backed by our extensive warranty and world-wide service network. To locate your nearest distributor or service agency, please contact us at the phone number and address listed on the bottom of each page.

You are in good company!

Sawyer Manufacturing Company is the world leader in the design and manufacture of pipeline and welding equipment and has been since 1948. Sawyer equipment has become a standard in the industry and continues to set the benchmark for quality and durability.

This user operation manual has been made to instruct you for the best use and operation of your Sawyer product. Your satisfaction with our products is our main goal. Please read this entire manual carefully, noting all tips, notes and warnings. Safety always comes first.

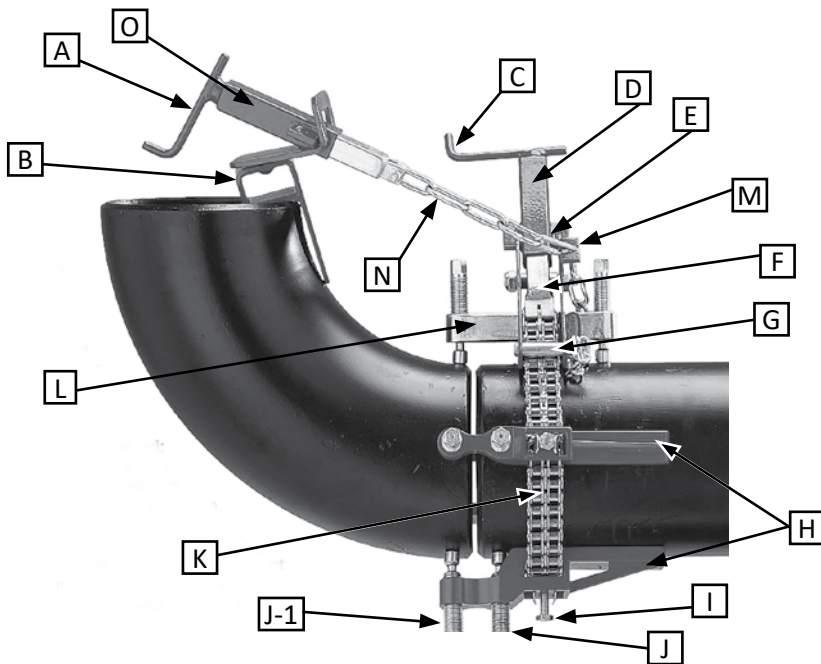

- A. Adjustment Handle
- B. Elbow Holding Block
- C. Adjustment Handle
- D. Fine Adjuster
- E. Fine Adjuster Wings
- F. Chain Lock Mechanism

- G. Chain Pin
- H. Jack Bars
- I. Chain Tightening Bolt
- J. Primary Jack Screw
- J-1. Secondary Jack Screw
- K. Chain

- L. Main Block
- M. Chain Link Holding Ears
- N. Chain Link
- O. Elbow Fine Adjuster
- P. Main Block Adjustment Wing Nut **not pictured**
- * Level & Support Device (combo of A,B,N&O)

WARNING

WARNING: Alignment handle is for alignment only. All reforming and aligning is to be done with primary and secondary jack screws.

CAUTION

CAUTION: Sawyer Manufacturing offers a precision chain clamp for the mating of two individual pipes together for easier welding. It is not intended to be used as an individual support or to lift the pipes. The chain clamp should only be used within its stated size range. All jack bars should face the same way and come in full contact with the pipes before final welding.

Record the following information for warranty purposes:

Where purchased: _____

Purchase date: _____

Equipment Serial #: _____

Warranty

All products manufactured by or for Sawyer Manufacturing Company are guaranteed against defects due to faulty workmanship or materials for twelve months from the date of purchase.

This guarantee is limited to the repair or replacement of any parts found to be defective, and no other liability—expressed, implied, or contingent—is assumed.

Installation

Tools Needed For Assembly

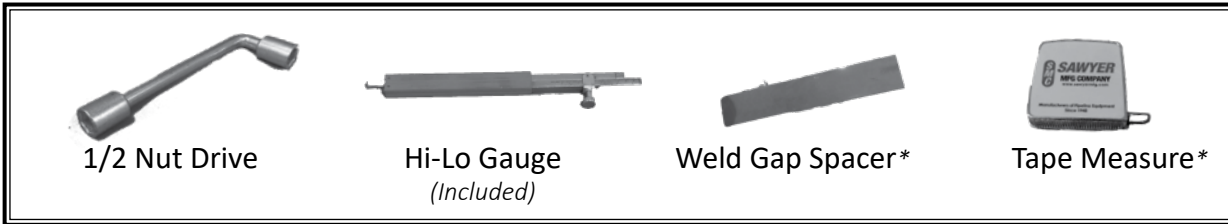

*Not Included

Note: Green colored chain clamps are made of stainless steel, red colored chain clamps are made of steel.

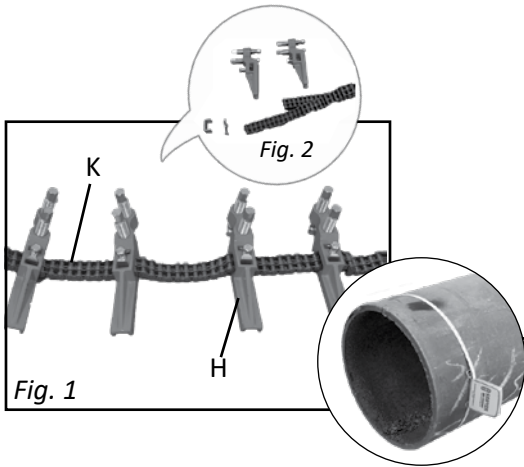

Straight Pipe Installation

1. Remove chain block at end of chain (K) to add or remove jack bars. (H, Fig. 1)

A. Measure pipe circumference and add or remove jack bars (H) as necessary.

Note: All jack bars (H) should face the same way.

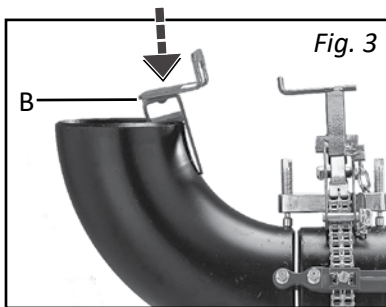

Elbow Pipe Installation

1. Place elbow holding block (B, Fig. 3) onto edge of pipe elbow.

Note: Elbow holding block (B) jack screw faces inward.

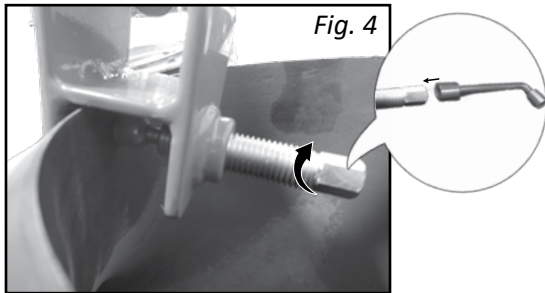

2. Tighten jack screw. (Fig. 4)

Tip: Use 1/2" nut drive.

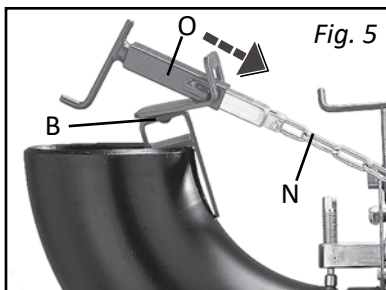

3. Place elbow fine adjuster (P, Fig. 5) and chain link (N, Fig. 5) through the elbow holding block. (B, Fig. 5)

Operation

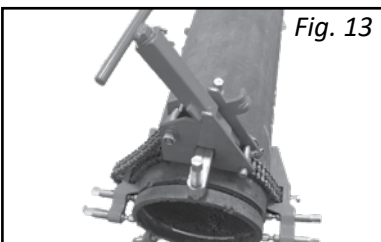
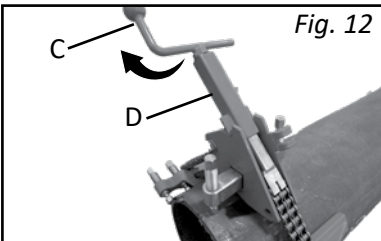
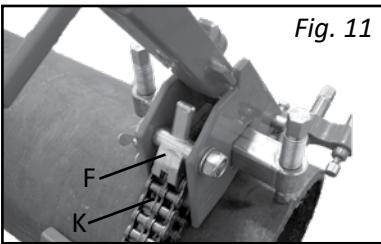
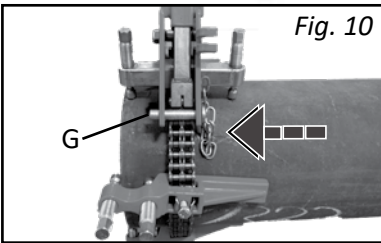
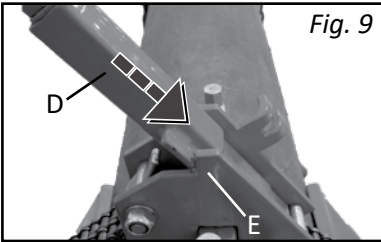
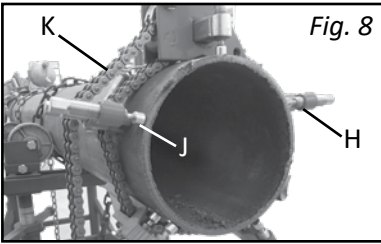
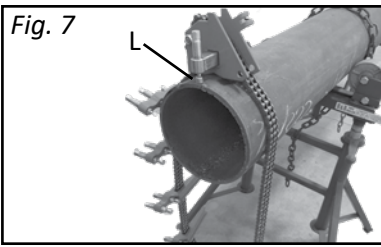

Straight Pipe Operation

1. Place main block (*L*, Fig. 7) onto top center of primary pipe.

2. Wrap chain (*K*) and jack bars (*H*) around primary pipe until jack screws (*J*) rest on pipe. (Fig. 8)

Note: Primary jack screws (J) rest near end of primary pipe.

3. Place fine adjuster (*D*) into fine adjuster wings. (*E*, Fig. 9)

4. Insert chain pin (*G*, Fig. 10) into place.

5. Lock chain (*K*) into chain lock mechanism. (*F*, Fig. 11)

6. Tighten fine adjustment (*D*) by turning adjustment handle. (*C*, Fig. 12)

Note: Chain (K) should fit snugly around primary pipe.

7. Mate secondary pipe to primary pipe. (Fig. 13)

Note: Clamp is not intended to be a support.

Operation

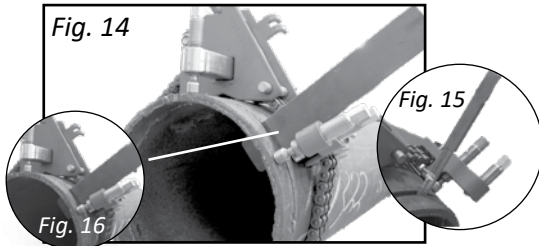

8. Use hi-lo gauge (Fig. 15) and spacer wedge (Fig. 16) to space gap between pipes. (Fig. 14)

Note: See Hi-Lo Gauge guide.

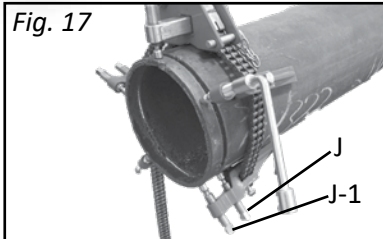

9. Adjust and tighten all jack screws. (J, J-1, Fig. 17)

Note: All jack screws (J, J-1) should have full contact with both pipes.

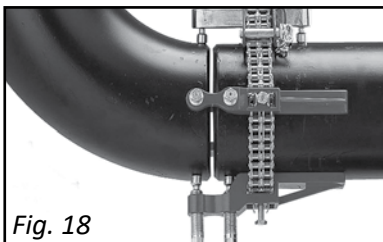

Elbow Pipe Operation

1. Mate elbow to primary pipe. (Fig. 18)

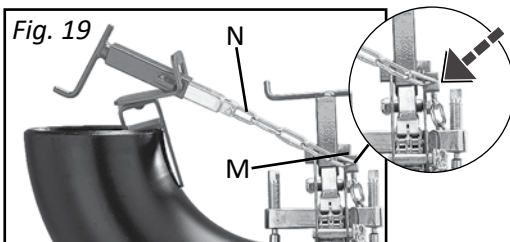

2. Insert chain link (N) into chain link holding ears. (M, Fig. 19)

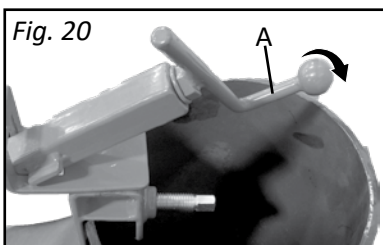

3. Tighten elbow adjustment handle. (A, Fig. 20)

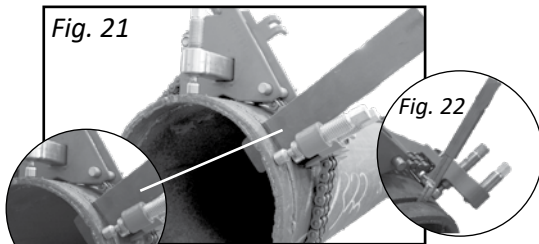

4. Use hi-lo gauge (Fig. 22) and spacer wedge (Fig. 23) to space gap between pipes. (Fig. 21)

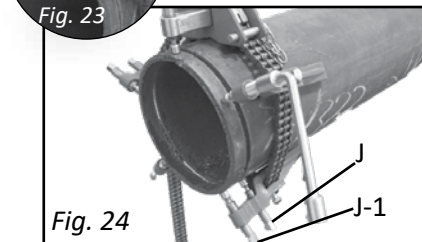

5. Tighten all jack screws. (J-J-1, Fig. 24)

Note: All jack screws (J, J-1) should have full contact with the pipe.