



# Accuwrap II Manual

Model 229B

## About Us

We appreciate your business!

Congratulations on your new SAWYER product. We are proud to have you as our customer and will strive to provide you with the best service and reliability in the industry. This product is backed by our extensive warranty and world-wide service network. To locate your nearest distributor or service agency, please contact us at the phone number and address listed on the bottom of each page.

## You are in good company!

Sawyer Manufacturing Company is the world leader in the design and manufacture of pipeline and welding equipment and has been since 1948. Sawyer equipment has become a standard in the industry and continues to set the benchmark for quality and durability.

This user operation manual has been made to instruct you for the best use and operation of your Sawyer product. Your satisfaction with our products is our main goal. Please read this entire manual carefully, noting all tips, notes and warnings. Safety always comes first.

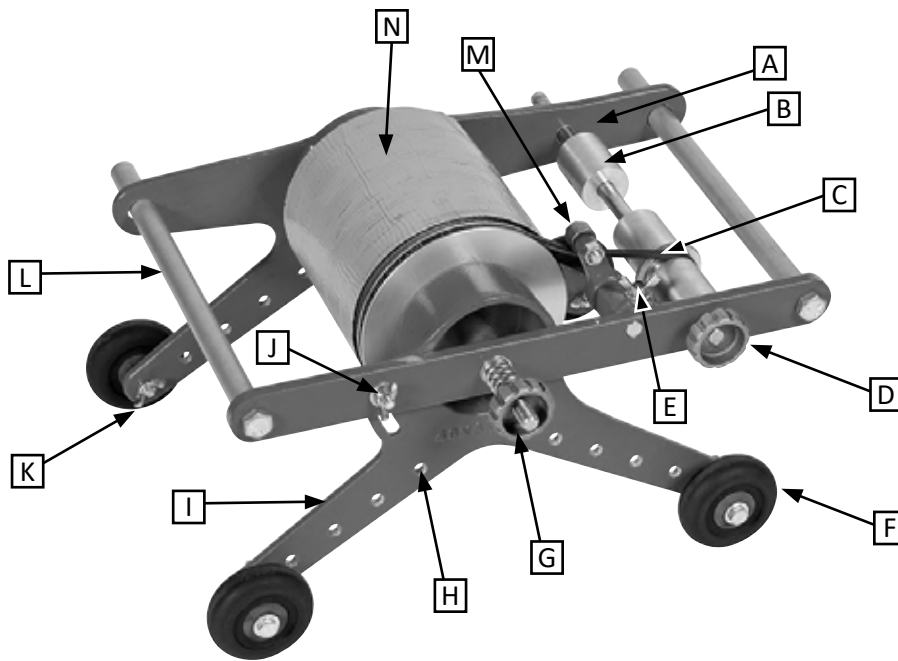

Note: Sawyer Accuwrap machines are sized by the width of the wrapping tape. They use; 2"-6" (50.8-152.4mm)  
6"-12" (152.4-304.8mm)  
12"-18" (304.8-457.2mm)  
Any Accuwrap machine will fit any size pipe.

- |                                     |                               |
|-------------------------------------|-------------------------------|
| A. Right Wing                       | I. Left Wing                  |
| B. Take-Up Wheels                   | J. Tape Lap Angle Wing-Nut    |
| C. Drive Belt                       | K. Wheel Wing-Nut             |
| D. Take-Up Knob                     | L. Handles                    |
| E. Belt Tension Wing-Nut            | M. Drive Belt Tensioner       |
| F. Pipe Roller Wheels               | N. Tape <i>*not included*</i> |
| G. Tape Tension Knob                |                               |
| H. Pipe Size Wheel Adjustment Holes |                               |

## ! CAUTION !

**CAUTION:** Sawyer Manufacturing offers a line of Accuwrap machines for the purpose of protecting pipe surfaces. Ensure that the machine is in operating order before wrapping pipe. Use caution when operating the Accuwrap. Do not wrap hot pipe and keep clear from flame. After each use clean and store in a warm, dry area.

## Warranty

All products manufactured by or for Sawyer Manufacturing Company are guaranteed against defects due to faulty workmanship or materials for twelve months from the date of purchase.

This guarantee is limited to the repair or replacement of any parts found to be defective, and no other liability—expressed, implied, or contingent—is assumed.

Record the following information for warranty purposes:

Where purchased: \_\_\_\_\_

Purchase date: \_\_\_\_\_

Equipment Serial #: \_\_\_\_\_

# Installation

## Tools Needed For Installation\*



1/8" allen wrench

\*Not Included

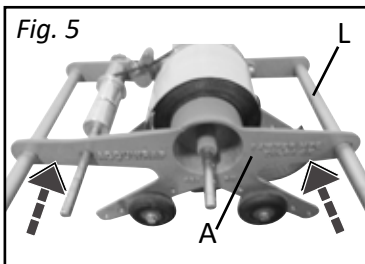
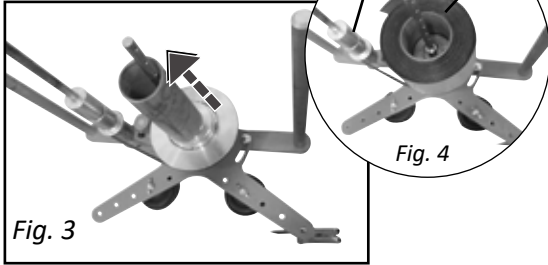
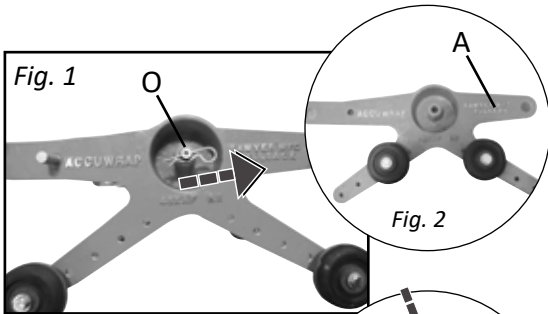

1. Remove tension pin clip. (*O*, Fig. 1)
2. Pull right wing (*A*) free from handles. (*L*, Fig. 2)
3. Remove cardboard tube and insert tape. (*N*, Fig. 3, Fig. 4)
4. Place right wing (*A*) onto handles. (*L*, Fig. 6)

## Tape with Release Liner

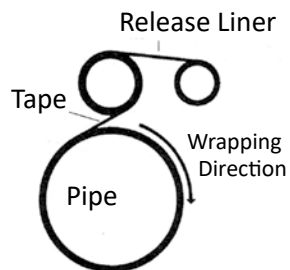

## Plain Tape

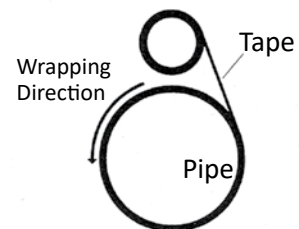

# Installation

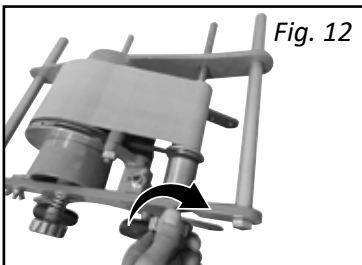
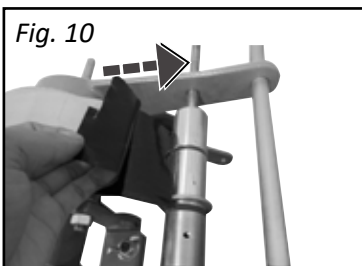
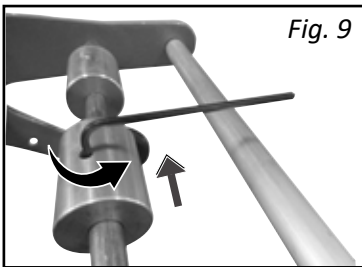
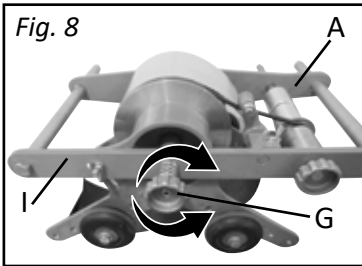
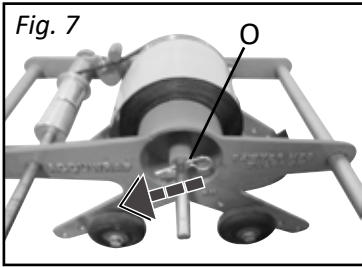

5. Re-insert tension pin clip. (O, Fig 7)

6. To tighten, turn tape roll in-between left wing (I) and right wing (A) using tape tension knob. (G, Fig. 8)

7. Adjust take-up wheels (B) to same width as tape roll. (N, Fig. 9)

Note: Use 1/8" allen wrench. (Fig. 9)

8. Peel back tape roll film and place film onto take-up wheels. (Fig. 10)

Note: Use tape to keep film in place, recommend cutting off a piece of tape for each take-up wheel. (Fig. 11)

Note: Cigarette Wrap- Set machine on flat surface, loosen lap angle wing nut (J), see that all four wheels are setting on the flat surface. Tighten lap angle wing nut (J).

Note: Spiral Wrap- Loosen lap angle wing nut (J), raise wheel nearest the lap angle wing nut (J) as required. The higher the wheel the greater the lap, tighten lap angle wing nut (J). This is a trial and error adjustment and will vary with different pipe sizes.

9. Turn take-up knob to start rolling film free from tape. (Fig. 12)

# Operation

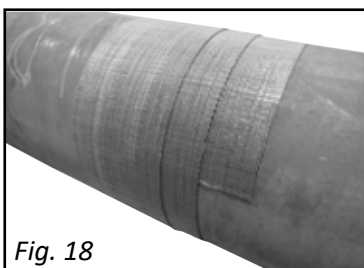
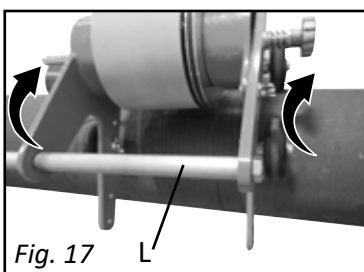
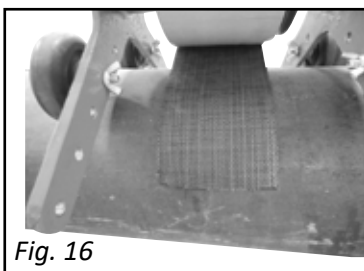
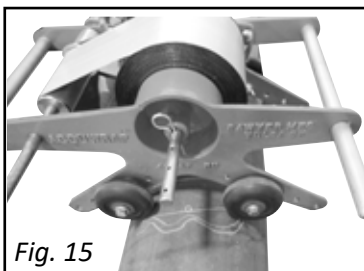
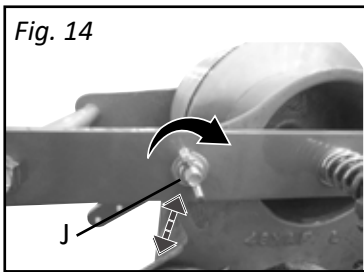
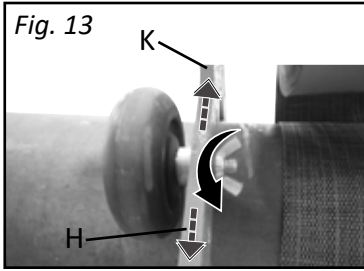

**1.** Take off wheel wing-nut (*K*) to move wheel up or down wheel adjustment holes (*H*) depending on pipe size. (*Fig. 13*)

**2.** Turn tape lap angle wing nut (*J*) depending on the amount of overlap wanted. (*Fig. 14*)

*Note: The higher the left wing the bigger the spiral lap; The more parallel the wings are the more of a straight wrap.*

**3.** Place accuwrap machine on pipe. (*Fig. 15*)

**4.** Pull a 6"-12" section of tape from under accuwrap and stick to pipe. (*Fig. 16*)

**5.** Using 2 people grab handles (*L*) wrap pipe. (*Fig. 17*)

*Note: For best results, wheels should never leave pipe.*

**6.** When finished wrapping cut tape and disassemble in opposite order of installation. (*Fig. 18*)