

About Us

We appreciate your business!

Congratulations on your new SAWYER product. We are proud to have you as our customer and will strive to provide you with the best service and reliability in the industry. This product is backed by our extensive warranty and world-wide service network. To locate your nearest distributor or service agency, please contact us at the phone number and address listed on the bottom of each page.

You are in good company!

Sawyer Manufacturing Company is the world leader in the design and manufacture of pipeline and welding equipment and has been since 1948. Sawyer equipment has become a standard in the industry and continues to set the benchmark for quality and durability.

This user operation manual has been made to instruct you for the best use and operation of your Sawyer product. Your satisfaction with our products is our main goal. Please read this entire manual carefully, noting all tips, notes and warnings. Safety always comes first.



Excalibur Manual

Cold Cutting Model 210

- 210H - Oil (Hydraulic Driven)
- 210E - Electric (Electric Driven)
- 210P - Air (Pneumatic Driven)

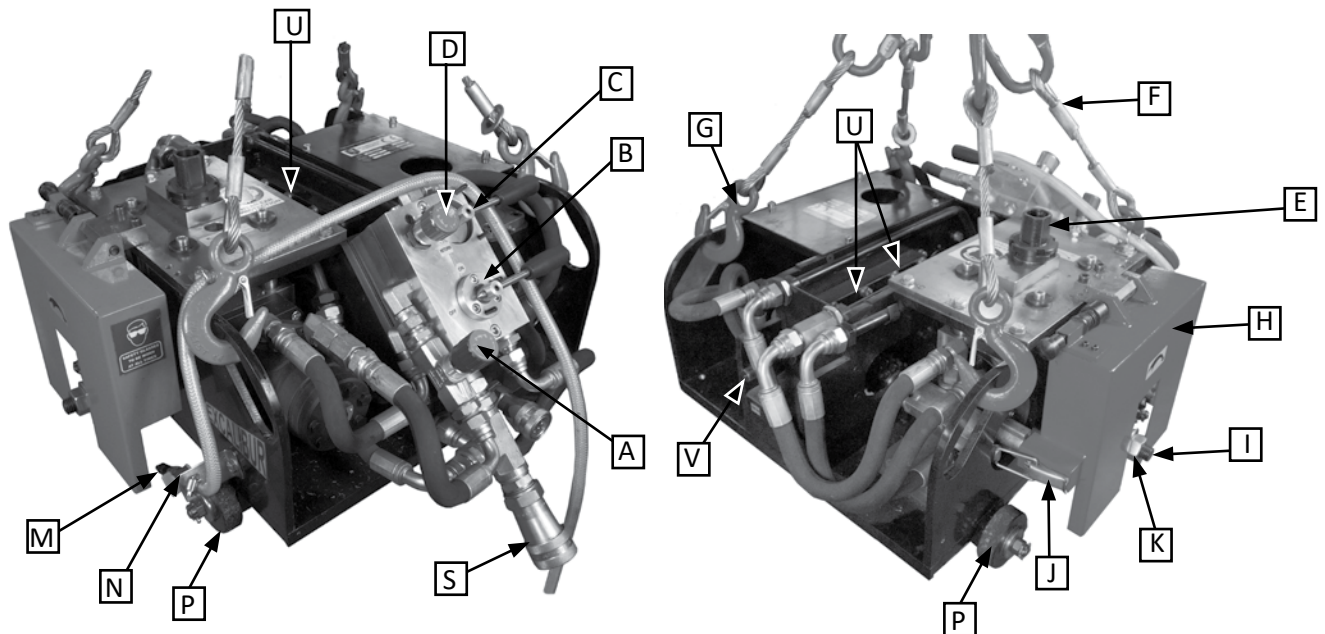

- A. Blade Speed Control
- B. Start/Stop Control
- C. Machine Directional Control
- D. Machine Speed Control
- E. Feed Screw
- F. Lifting Cables
- G. Lifting Spring Clips
- H. Blade Safety Cover
- I. Cutter Spindle
- J. Blade Safety Device
- K. Cutter Lock Nut & Cutter Collar Support
- L. Milling Cutter (not shown)
- M. Lubricator Nozzle
- N. Double Mist Lubrication System
- O. Coolant Container (not shown)
- P. Guide Wheels
- Q. Guide Wheel Tracks (not shown)
- R. Socket Head Cap Screws (not shown)
- S. Hydraulic Hose Connector
- T. Drive Chain (not shown)
- U. Drive Chain Sprockets
- V. Chain Tensioning Screw

Record the following information for warranty purposes:

Where purchased: _____

Purchase date: _____

Equipment Serial #: _____

Warranty

All products manufactured by or for Sawyer Manufacturing Company are guaranteed against defects due to faulty workmanship or materials for twelve months from the date of purchase.

This guarantee is limited to the repair or replacement of any parts found to be defective, and no other liability—expressed, implied, or contingent—is assumed.

Installation

Tools Needed For Installation and Operation/Cutting*

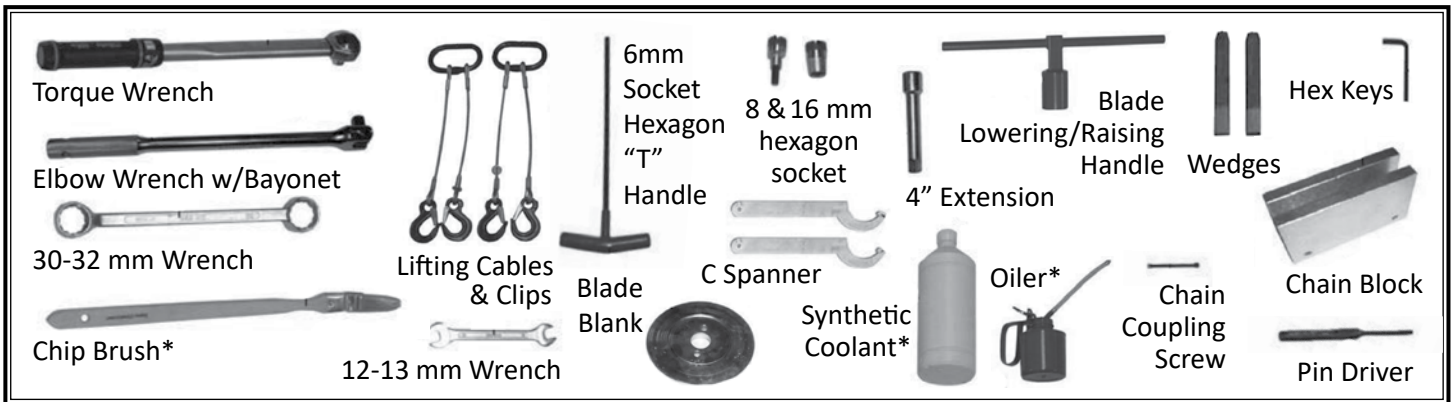

*Not Included

Installation

Photos in this manual are of the Hydraulic Machine

1. Connections and Power Sources

A. Hydraulic Machine

1. Connect machine to hydraulic power supply (Fig. 1) with the capability of minimum pressure of 100 bars at 72 L/min. with 25 micron filter and air-cooled heat exchanger.
2. Ensure power supply is connected properly by checking for clockwise rotation of blades.
3. Connect the Double Mist Lubrication System (M, Fig. 2) to the Coolant Container (N). Use a synthetic coolant oil type BIO/42 EP or similar.

Note: A small air compressor is required to operate the Automatic Double Mist Lubrication system.

4. Turn the Start/Stop Control (B, Fig. 3) to the On position to ensure clockwise rotation of blades. Turn Off.

Tip: If hydraulic hose longer than 50 feet (15 meters) is required, the hose diameter should be increased accordingly to ensure adequate pressure and volume of air.

B. Pneumatic Machine

1. Connect machine to compressor with a minimum capacity of 4000 liters and pressure of 116psi (8 bars).
2. The regulator of the air filter/lubrication device should be set at 90psi (6 bar).
3. Connect the Cutter Lubricator System to the coolant container. Use a synthetic coolant oil type BIO/42 EP or similar.
4. Turn the Start/Stop Control to the On position to ensure clockwise rotation of blades. Turn Off.

Note: An air regulator, filter and lubricator group must always be installed in the air supply line between Excalibur and the air compressor.

Tip: If air hose longer than 50 feet (15 meters) is required, the hose diameter should be increased accordingly to ensure adequate pressure and volume of air.

C. Electric Machine

1. Connect machine to 3-phase, 380/440V power supply with N and E.
2. Connect the Double Mist Lubrication System to the Coolant Container. Use a synthetic coolant oil type BIO/42 EP or similar.

Note A small air compressor is required to operate the Automatic Double Mist Lubrication system.

4. Turn the Start/Stop Control to the On position to ensure clockwise rotation of blades. Turn Off.

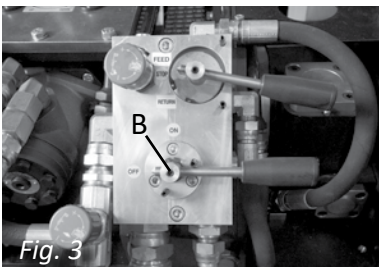
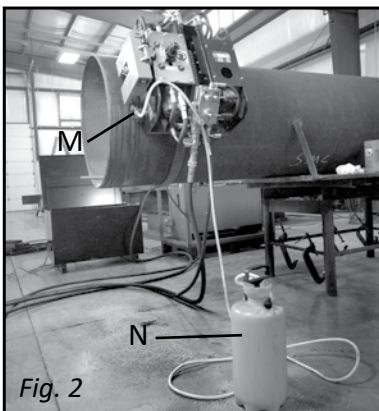
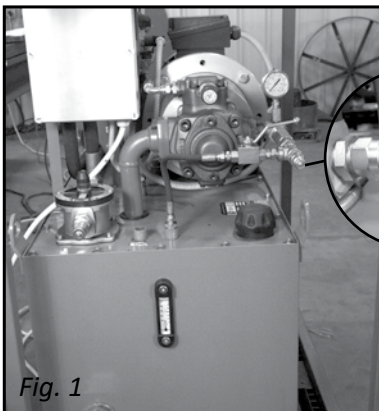

Installation

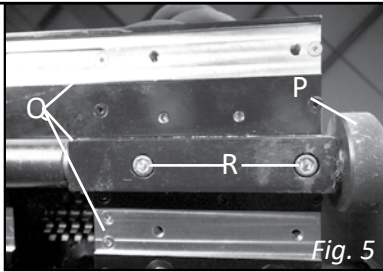

Fig. 5

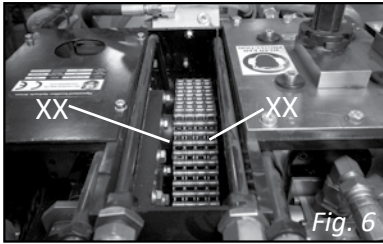

Fig. 6

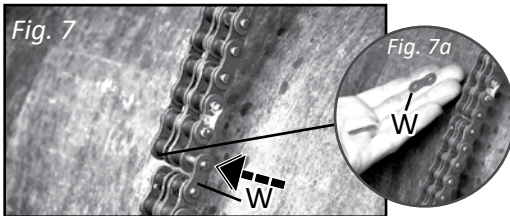

Fig. 7

Fig. 7a

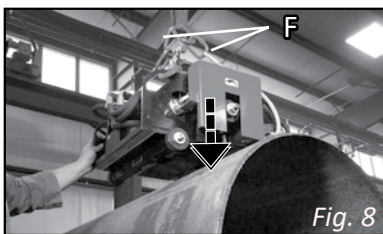

Fig. 8

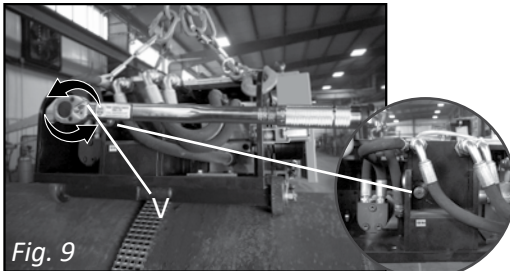

Fig. 9

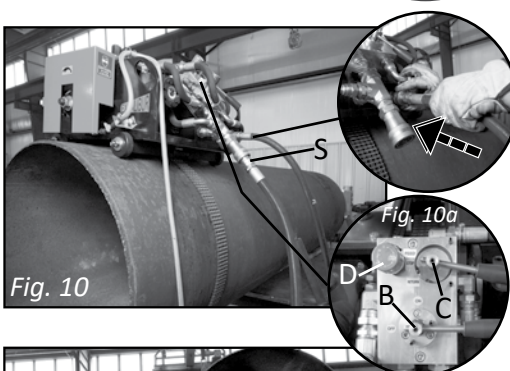

Fig. 10

Fig. 10a

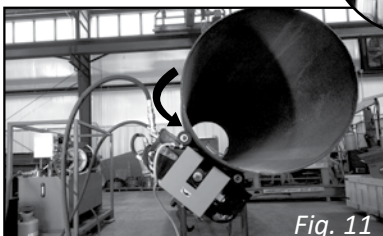

Fig. 11

2. Setting Guide Wheels for the pipe diameter to be cut

Note: Special wheels are required for installation on 6" pipe

- A. Lift machine and verify the wheel holders holding the Guide Wheels (P, Fig. 5) are attached in the correct Guide Wheel Slots (Q) for the diameter of pipe to be cut.

Tip: If a position change is required, remove the four Socket Head Cap Screws (R, Fig. 6), fit wheel supports in the proper slots for the diameter being cut and reinstall the screws.

3. Installing the Drive Chain

- A. Thread the Drive Chain (T) through the machine and onto the Drive Chain Sprockets (Fig. 6, xx). Refer to Table 1, page 6
- B. The required Drive Chain length is determined by the diameter of the pipe to be cut.

C. Lengthen the Drive Chain.

1. Select the chain segments required to lengthen the chain
2. If the chain is unjoined, proceed to the next step. If chain is joined, then remove a single chain pin (W, Fig. 7a).

Tip: Use a pin hammer

3. Add the required amount of additional chain to the ends and secure (Fig. 7) using a Chain Link Kit (optional).

D. Shorten the Drive Chain.

1. Select the chain segments required to shorten the length.
2. If the chain is unjoined, proceed to the next step. If chain is joined, then remove a single chain pin (W, Fig. 7a).

Tip: Use a pin hammer

3. Measure from the unlinked chain point to the correct length and remove the excess chain. Repeat previous step and secure (Fig. 7)

4. Installing the Excalibur on the pipe

- A. Using the two lifting cables (F, Fig. 8), lift the Excalibur onto the pipe.
- B. Join two chain ends with the chain coupling pins or the chain coupling link, and then release the lifting mechanism.
- C. Tighten the mesh chain by rotating the Chain Tensioning Screw (V, Fig. 9) counterclockwise with the 16 mm Swivel T Handle.
- D. Torque the Chain Tensioning Screw (V) to 96 ft./lb. (130NM).
 1. Release the tension on the two Lifting Cables (F) and unhook the Lifting Spring Clips (G) from the machine.
- E. Connect the air/hydraulic power source by supply cables to the Hydraulic Hose Connector (S, Fig. 10) on the Excalibur, and start the power source.
 1. Turn the Start/Stop Control to the ON position. (B, Fig. 10a)

Note: Hydraulic Model only – If this is the first time the hydraulic power supply is being run, let the hydraulic fluid circulate through the machine 15-20 minutes to remove air bubbles from the fluid.

2. Move the Machine Directional Control (C, Fig. 10a) to the forward position.
3. Turn the Machine Speed Control (D, Fig. 10a) valve counter-clockwise.
4. Rotate the Excalibur one full turn around the pipe to align the chain. (Fig. 11)

Note: Verify there is enough clearance for the machine to travel around the pipe.

5. Re-torque the Chain Tensioning Screw (V, Fig. 9) to 96 ft./lb. (130NM).
6. Turn off the air/hydraulic power source.

Tip: Open pressure bypass valve before turning off power to the Excalibur.

Installation

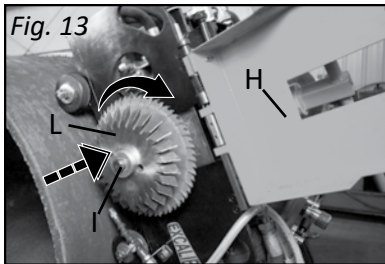
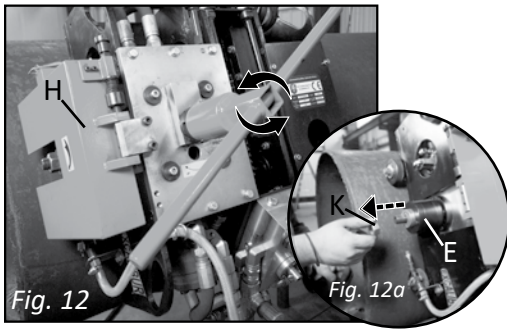

5. Installing Center and Beveling Cutters

- A. With the aid of the Blade Lowering/Raising Handle, turn the Feed Screw (E, Fig. 9) clockwise until the cutter spindle is raised to its highest position.
- B. Open the Blade Safety Cover (H, Fig. 12a) and loosen the Cutter Lock Nut (K) by rotating it clockwise. Remove the Cutter Lock Nut, washer and Cutter Support Collar (K).

Note: Remove all metal chips and debris from the wheel supports and slots in the bottom of the chassis.

- C. Place the Milling Cutter (L, Fig. 12a) on the Cutter Spindle (I) so the cutting edge is facing downward.

Note: All teeth must face clockwise, as indicated by the arrow on the Cutter Safety Cover

- D. Align the holes in the Milling Cutter (L) with the two hardened pins and push the Milling Cutter forward until it contacts the face of the male cutter drive collar. Follow the same procedure to install the center Milling Cutter and the second Milling Cutter.

- E. Install the Cutter Support Collar, washer and Cutter Lock Nut. (K, Fig. 13)
- F. Lower the Cutter Safety Cover (H) and latch the Blade Safety Device (J) to the cover.

Note: The machine will not function if blade safety cover is not latched to the blade safety device.

Operation

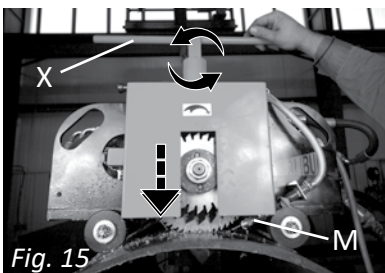
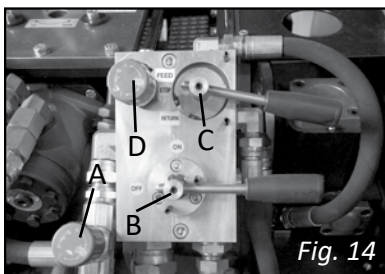
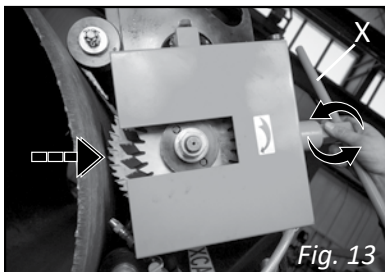

1. Preparation for the cutting process

- A. With the Blade Lowering/Raising Handle, (X, Fig. 13) turn the Feed Screw (E) until the Cutter Spindle (I) is raised to its highest position.
- B. Turn the Start/Stop Control (B, Fig. 14) to the Off position.
- C. Turn the Machine Directional Control (C, Fig. 14) to the Stop position.
- D. Turn the Machine Speed Control (D, Fig. 14) clockwise to the 0 or fully closed position.
- E. Turn the Blade Speed control (A, Fig. 14) clockwise to the 0 or fully closed position.

Note: Ensure the safety cutter cover is closed and the blade shut-off device is latched to the cover.

- F. Turn off the air/hydraulic power source and bleed the pressure from the supply hoses.
- G. Connect and secure the air/hydraulic hose quick disconnects to the Excalibur.

Note: Air filter/lubrication device must be placed in the center of the two air hoses. Make sure the blow of the lubricator assembly is filled with pneumatic oil.

- H. Start the power supply.
- I. Verify correct air/hydraulic output pressure and flow rate.

2. Using the Excalibur for the cutting process

- A. Turn the air valve of the Double Mist Lubrication System device On.
- B. Adjust the Lubricator Nozzle (M) as needed to provide a steady flow of coolant on the blades.
- C. With the Blade Lowering/Raising Handle, (X, Fig. 15) turn the Feed Screw (E) counter-clockwise until the Milling Cutters (L) are through the thickness of the pipe at desired depth.

Operation

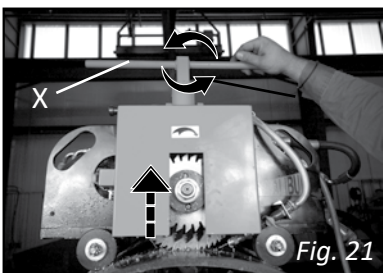
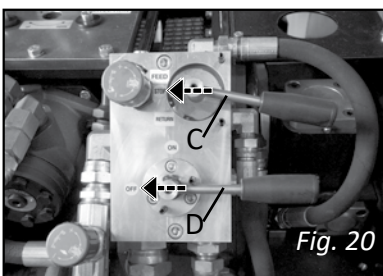
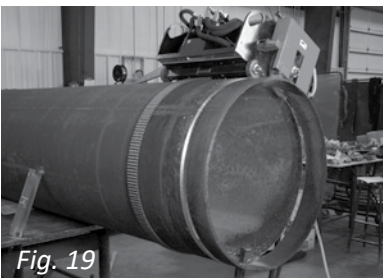
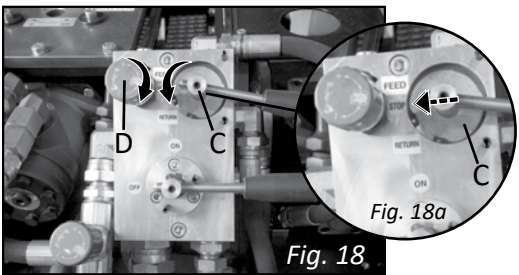
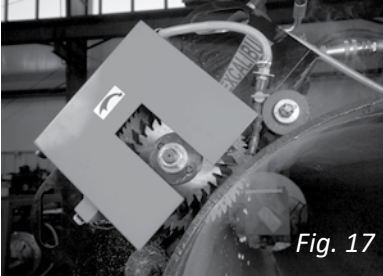
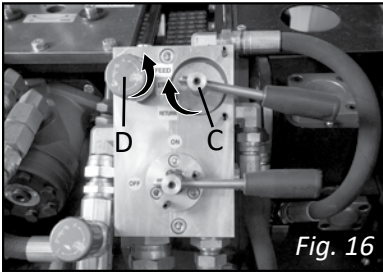

D. Remove the Blade Lowering/Raising Handle (*X*) from the Feed Screw (*E*), and with the column tensioning wrench provided, tighten the four hex head cap screws that hold the blade transmission securely to the four columns.

E. Turn the Machine Directional Control (*C*, Fig. 16) to the Feed position.

Note: Never attempt to cut pipe by placing the forward control knob in the REVERSE position.

F. Slowly open the Machine Speed Control (*D*, Fig. 16) until the desired forward (feed) speed is achieved.

Note: Check to see if the desired cut and bevel depth are being achieved.

G. Cut the pipe (Fig. 17), machine will travel full rotation around the pipe.

H. Cutter stoppage

1. If a cutter block occurs, quickly turn the Machine Directional Control (*C*, Fig. 18) to the Return position and leave it in that position until the cutters start rotating.
2. When the cutters begin rotating, move the Machine Directional Control (*C*, Fig. 18a) to the Stop position.
3. Close the Machine Speed Control (*D*, Fig. 18) a small amount.
4. Turn the Machine Directional Control (*C*, Fig. 16) to the Feed position.

I. When the cut is complete, move the Machine Directional Control (*C*, Fig. 20) to the Stop position.

1. Loosen the four hex head cap screws holding the blade transmission securely to the four columns.
2. Using the Blade Lowering/Raising Handle, (*X*, Fig. 21), rotate the Feed Screw (*E*) until the Milling Cutters (*L*) are raised to their highest position.
3. Turn the Start/Stop Control (*B*, Fig. 20) to the Off position.
4. Turn the air valve of the Double Mist Lubrication System (*N*) to the Off position.
5. Turn off the air/hydraulic power supply.
6. Bleed all air/hydraulic pressure from the hoses, and disconnect the hoses from Hydraulic Hose Connector (*S*) on the Excalibur.

3. Disconnecting the power source

A. Hydraulic Machine

1. Turn off the hydraulic power supply.
2. Bleed all hydraulic pressure from the hoses by rotating the cutter control knob back and forward to the OFF and ON position several times.
3. Disconnect the air hose from the Excalibur.

B. Pneumatic Machine

1. Turn off air supply.
2. Bleed all air pressure from the hoses by rotating the cutter control knob back and forward to the OFF and ON position several times.
3. Disconnect the air hose from the Excalibur.

C. Electric Machine

1. Turn off the hydraulic power supply.

Routine Maintenance

Tip: Plan all routine maintenance when the machine is not in operation. When the machine is cutting "heavy wall or high strength alloy pipes", it is recommended the machine be thoroughly checked after each cut.

General

1. Inspect the Cutter Blades for wear and the integrity of the edge after each cut.

2. Check the Double Mist Lubrication System on a regular basis during the cutting process. (if applicable)

- A. Check nozzles for obstruction after each use. Clean as necessary.

Note: Always keep the synthetic coolant plastic bottle clean to avoid debris or dirt that may obstruct the Lubrication Nozzle (M).

Pneumatic Machine

1. Check the Air Filter / Lubrication Device and periodically check the assembly to be certain it is functioning properly when using the Air Drive Excalibur.

A. Drain the water from the water separator of the Air Filter/ Lubrication Device on a regular basis.

B. Replenish the oil in the inline Lubricator of the Air Filter/ Lubrication Device with pneumatic oil as needed.

2. Electric power supply and cables should be checked prior to each use of the machine.

Note: Periodically check the Air or Hydraulic Power Supply.

Hydraulic Machine

Tip: To obtain the best performance, it is important to use a hydraulic fluid with the best viscosity index for the ambient temperature in which the machine will be working. Under extreme conditions, use synthetic additive oil with a high degree of stability.

Note: for applicatons with vegetable biodegradable oil and special mixture, contact Sawyer prior to use.



- A. Filter hydraulic fluid through a 25 micro filter when adding oil to the Hydraulic Power Supply reservoir

Note: Failure to filter the fluid may cause damage to the hydraulic blade and forward motors. Use the same hydraulic oil that was originally in the reservoir.

Lubrication Guide

1. The following parts must be oiled once weekly.
with Lubricating Oil Specification: ISA VG 68, Viscosity 68 & Density 0.887
 - A. Upper and Lower Gibs
 - B. Chain Tension Screw.
 - C. Bronze Bushings.
 - D. Axle.
 - E. Depth Control Assembly.
2. The following part must be oiled every 2 weeks.
 - A. Bronze Wheel Bearing.
3. The following part must be oiled daily.
 - A. Guide Rod.
 - B. Install torch inside torch holder.
 - C. Tighten adjustment knob.
4. The Main Transmission Unit and the Feed Transmission Unit must be greased using Lithium based high melting point grease after every 10-15 hours of usage.
5. Regarding the chain, this must be inspected, cleaned and oiled at least once every week.

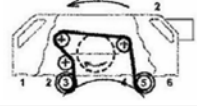
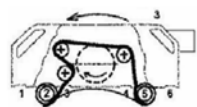
Table 2. Positioning of the wheels for various pipe diameters and cutting depths

Wheel Position		Nominal Pipe Size In / mm	Chain Length In / mm
Wheel Position, Cutter Rotation & Machine Direction	Wheel Setting		
	3 & 4	6 / 152	42 / 1065
	3 & 4	8 / 203	47 / 1192
	3 & 4	10 / 254	55 / 1395
	3 & 4	12 / 305	61 / 1547
	3 & 5	14 / 356	63 / 1598
	3 & 5	16 / 408	69 / 1750
	3 & 5	18 / 457	76 / 1918
	2 & 5	20 / 508	82 / 2070
	2 & 5	24 / 610	92 / 2335
	2 & 5	30 / 762	114 / 2892
	2 & 5	32 / 810	116 / 2940
	2 & 6	36 / 914	137 / 3476
	2 & 6	40 / 1016	144 / 3650
	2 & 6	42 / 1067	156 / 3950
	1 & 6	48 / 1200	165 / 4180
	1 & 6	54 / 1400	183 / 4648
	1 & 6	60 / 1500	214 / 5435
	1 & 6	72 / 1800	244 / 6197