



# Chain Beveling Machine Manual

Model: 207

# MX1 Beveling Machine Manual

Model: 207

## About Us

We appreciate your business!

Congratulations on your new SAWYER product. We are proud to have you as our customer and will strive to provide you with the best service and reliability in the industry. This product is backed by our extensive warranty and world-wide service network. To locate your nearest distributor or service agency, please contact us at the phone number and address listed on the bottom of each page.

### You are in good company!

Sawyer Manufacturing Company is the world leader in the design and manufacture of pipeline and welding equipment and has been since 1948. Sawyer equipment has become a standard in the industry and continues to set the benchmark for quality and durability.

This user operation manual has been made to instruct you for the best use and operation of your Sawyer product. Your satisfaction with our products is our main goal. Please read this entire manual carefully, noting all tips, notes and warnings. Safety always comes first.

## Parts Diagrams

Chain Beveling Machine

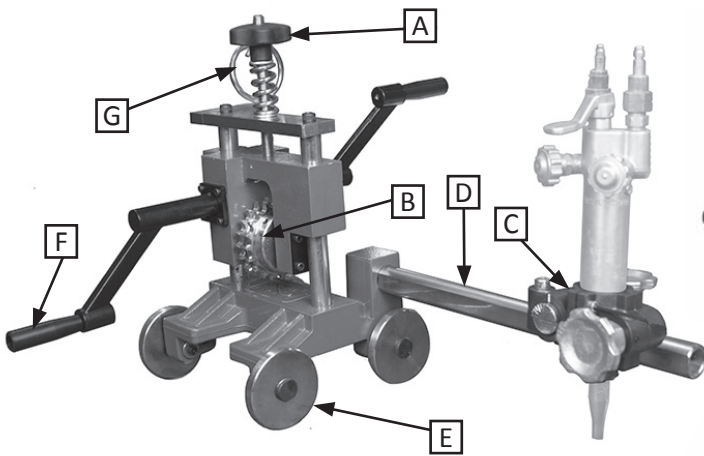

MX1 Beveling Machine

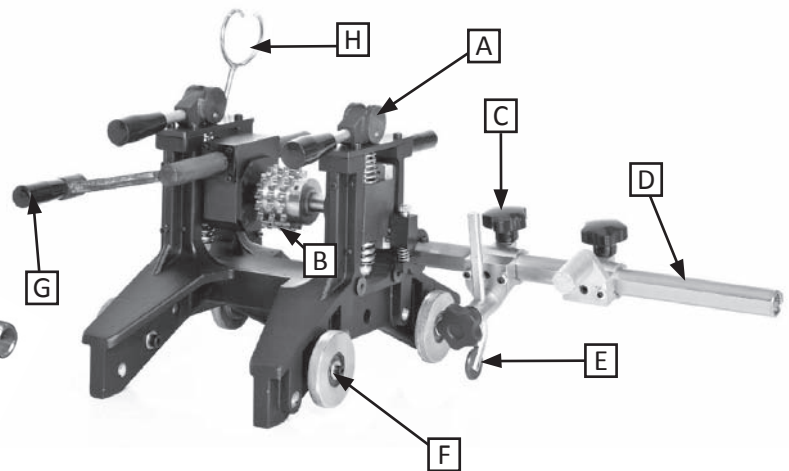

- |                                     |                 |
|-------------------------------------|-----------------|
| A. Chain Tensioning Knob            | E. Wheels       |
| B. Chain Gear                       | F. Crank Handle |
| C. Adjustable Rack Torch Holder     | G. Cable Tidy   |
| D. Adjustable Rack Torch Holder Arm |                 |

- |                                 |                        |
|---------------------------------|------------------------|
| A. Chain Tensioning Handle      | E. Out of Round Device |
| B. Chain Gear                   | F. Wheels              |
| C. Torch Support                | G. Crank Handle        |
| D. Adjustable Rack Torch Holder | H. Cable Tidy          |

Record the following information for warranty purposes:  
 Where purchased: \_\_\_\_\_  
 Purchase date: \_\_\_\_\_  
 Equipment Serial #: \_\_\_\_\_

**Warranty**  
 All products manufactured by or for Sawyer Manufacturing Company are guaranteed against defects due to faulty workmanship or materials for twelve months from the date of purchase.  
 This guarantee is limited to the repair or replacement of any parts found to be defective, and no other liability—expressed, implied, or contingent—is assumed.

# Installation

## Tools Needed For Operation\*

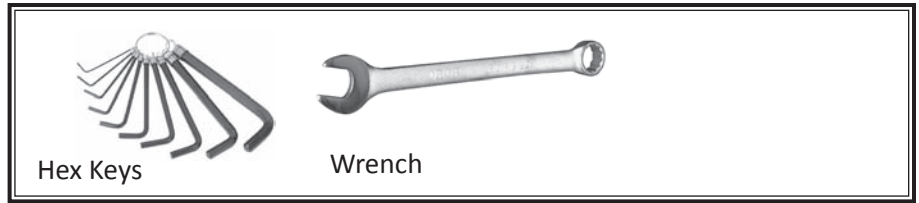

\*Includ-

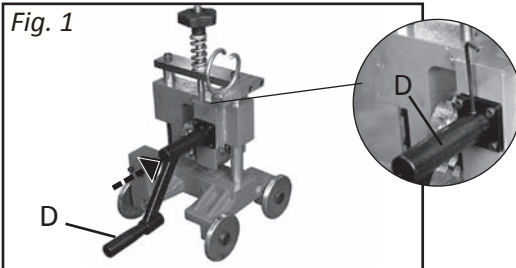

1. Attach Crank Handle (E) to the Chain Beveling Machine by mounting to the post and tightening with the 3 mm hex key

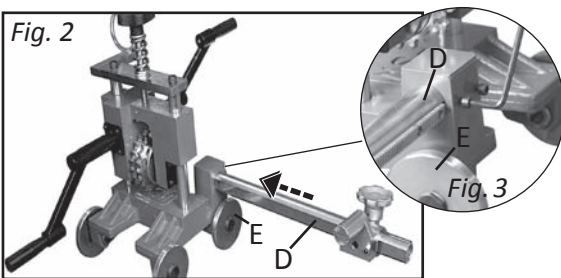

2. Install Adjustable Rack Torch Holder  
A. Slide the Adjustable Rack Torch Holder Arm (D) into the hole above the wheel (E, Fig. 2)  
B. Tighten with the 4 mm hex key (Fig. 2)

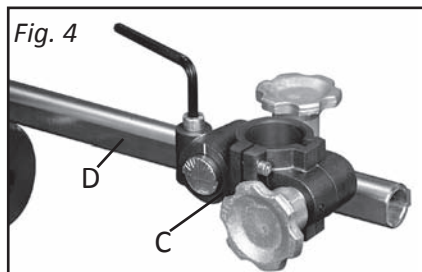

3. Install the Adjustable Rack Torch Holder (C) onto the Adjustable Rack Torch Holder Arm (D) into the and tighten with the 5 mm hex key (Fig. 2)

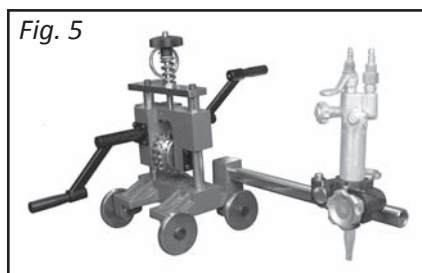

4. Final picture of finished Chain Beveling Machine (Fig. 5)

# Installation

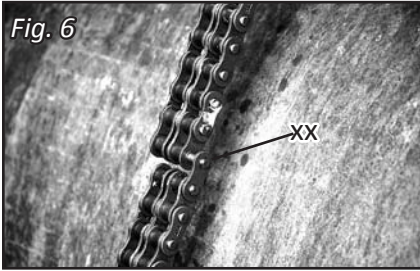
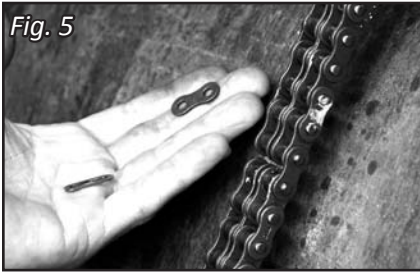

## Chain Length

1. The required Drive Chain length is determined by the diameter of the pipe to be cut. (Table 1)
2. Lengthen the Drive Chain.
  - A. Select the chain segments required to lengthen the length (Table 1)
  - B. If the chain is unjoined, proceed to the next step. If chain is joined, then remove a single chain pin (Fig. 5, xx)  
*Tip: Use a pin hammer*
  - C. Add the required amount of additional chain to the ends and secure (Fig. 5, xx) using a Chain Link Kit (optional)
3. Shorten the Drive Chain.
  - A. Select the chain segments required to shorten the length (Table 1)
  - B. If the chain is unjoined, proceed to the next step. If chain is joined, then remove a single chain pin (Fig. 5, xx)  
*Tip: Use a pin hammer*
  - C. Measure from the unlinked chain point to the correct length and remove the excess chain. Repeat previous step and secure (Fig. 5, xx) using a Chain Link Kit

Table 1

Length of chain required for different pipe diameters

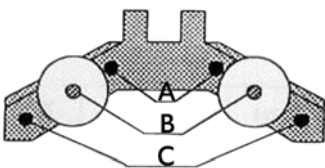

Pipe diameter* In/mm	4 / 102	6 / 152	8 / 203	10 / 254	12 / 305	16 / 406	18 / 457
Wheel Position	A	B	B	B	B	B	B
Chain length (In/mm)	28 / 711	34 / 864	40 / 1016	46 / 1168	52 / 1321	62 / 1575	68 / 1727
Pipe diameter* In/mm	20 / 508	22 / 559	24 / 610	26 / 660	28 / 711	30 / 762	32 / 813
Wheel Position	B	B	B	B	B	B	B
Chain length (In/mm)	74 / 1881	80 / 2032	86 / 2184	93 / 2362	99 / 2515	105 / 2667	111 / 2819
Pipe diameter* In/mm	36 / 914	38 / 965	40 / 1016	42 / 1067	48 / 1219	50 / 1270	52 / 1321
Wheel Position	B	B	B	C	C	C	C
Chain length (In/mm)	123 / 3124	129 / 3277	135 / 3429	142 / 3607	161 / 4089	167 / 4242	173 / 4394

\* The pipe diameter listed is the nominal pipe size; for the actual pipe outside diameters refer to a commercial pipe chart to calculate the nominal pipe size or contact [info@sawyerfmfg.com](mailto:info@sawyerfmfg.com) for clarification. For sizes larger than 52", please

# Operation

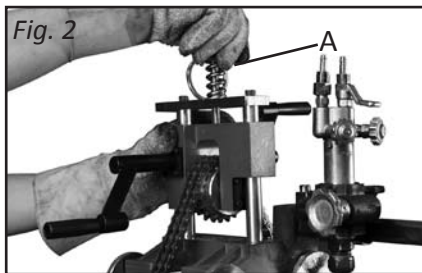
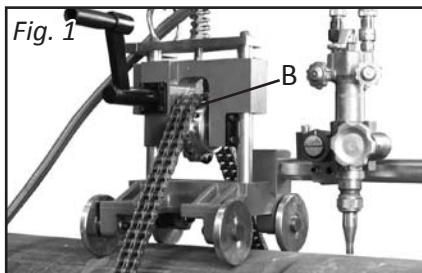

## Cutting Pipe

**1.** Set the beveling machine on the pipe. Place chain over the Chain Gear (B, Fig. 1) and allow to flow down over each side of the pipe between the wheels.

**2.** Connect the chain ends.

*Tip: Use a Chain Link Kit (optional)*

**3.** Adjust the tension for a secure fit to the pipe.

A. For the Chain Beveler, turn the Chain Tensioning Knob (Fig.2, A)

B. For the MX1 Beveler, pull the Chain Tensioning Handles (A) simultaneously to apply the required tension

*Tip: For a square cut, rotate the beveling machine around the pipe once to ensure the chain is squared with the pipe*

*Note: Guide Band is recommended for Pipe 18" and larger. If the pipe is spiral welded, excessively out of round or is vertical or angled; it may be necessary to use a Guide Band for accuracy.*